

K145 (2.2)

*SIMCA/CITROEN*

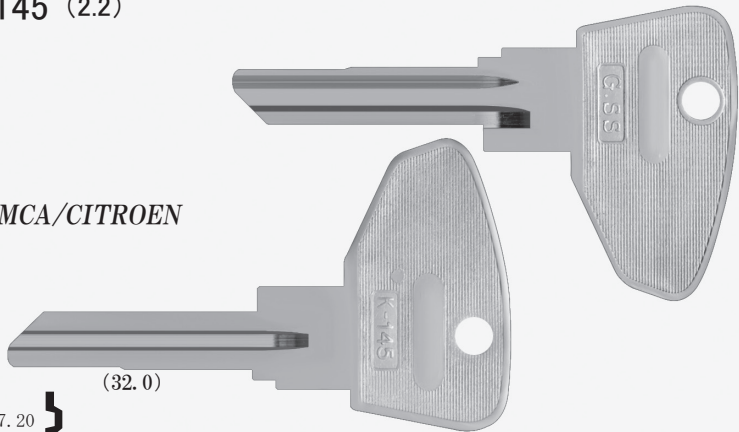

(32.0)

7.20

メーカー別

2-10・72P

溝別

P89