

K157 (2.2)

(25.4)

*OPEL*



7.20

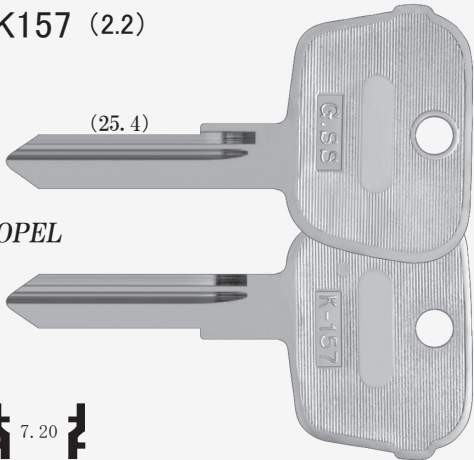

メーカー別 2-68P

溝別 P170